

Magnetic drive pumps

MDM series

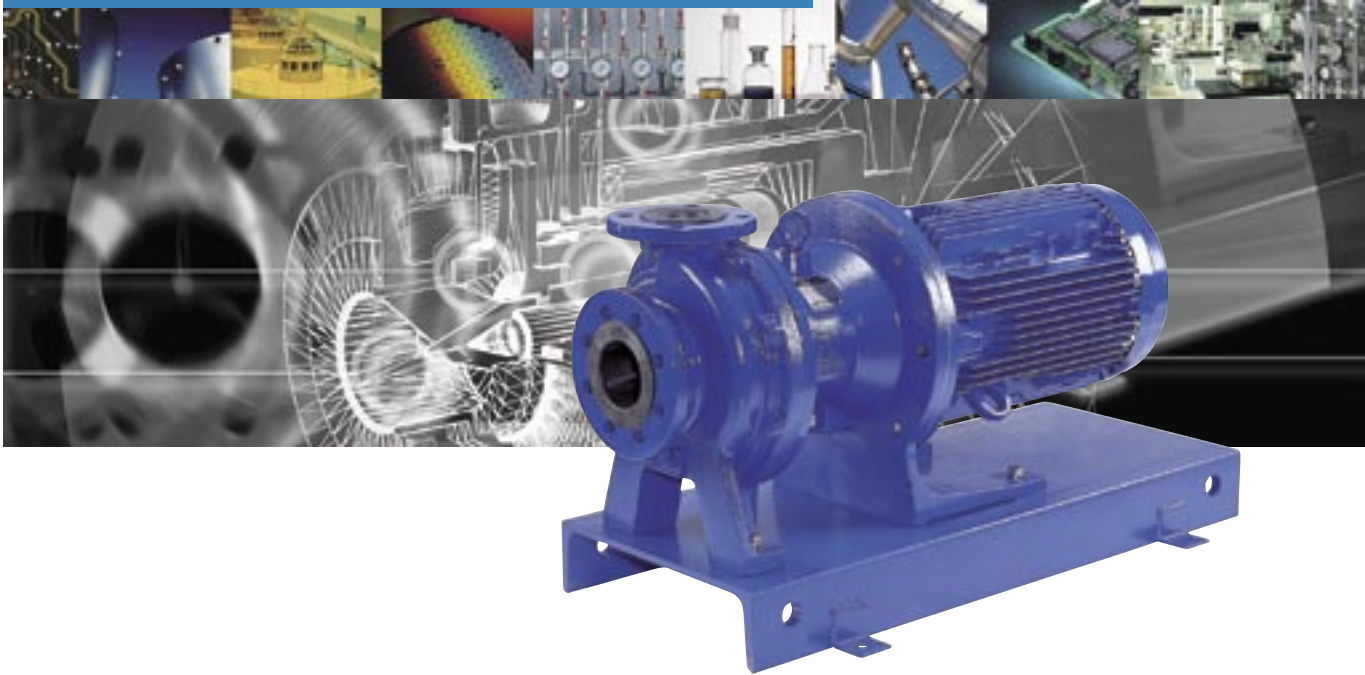

Patent
JAPAN / U.S.A. / TAIWAN

Pat.Pend.
EU / KOREA / CHINA



Magnetic drive process pump resistant to dry run damage

The MDM Series of Magnetic drive process pumps have wetted parts made of fluororesin. Natural PFA and CFRETFE being standard materials of construction. The MDM features a unique mechanism which gives a greatly improved performance against dry running (Non contact system). Applications cover a wide range of chemical process duties from acid to alkali together with high purity chemicals for the semiconductor industry.

Unique design prevents dry running

(Non contact system)

The pump design features a mechanism to withstand dry running. High magnet power of the rare earth magnets prevents the magnet capsule coming into contact with the thrust ring of the rear casing, thus preventing melting of fluororesin components due to heat generation. This greatly improves resistance against dry running in comparison with conventional magnetic drive pumps made of fluororesin.

Note: Only CF type (fitted with high density carbon bearing) can cope with dry running. Dry running is not permitted in the case of KK type.

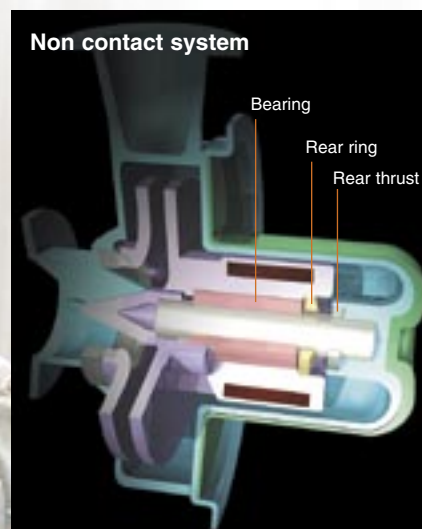

MDM65(ETFE type)

ETFE and PFA available in standard models

Carbon fibre reinforced ETFE (CFRETFE) and PFA linings can be supplied to meet many varying duties. PFA being a natural unfilled material generates fewer contaminants and makes it ideally suited for transfer of high purity chemicals.

Highly durable structure

A ductile cast iron shell adds strength and durability to the outer peripheral surfaces of the fluoro-resin pump module. The rear casing which is placed under the highest stress is protected by a rear casing cover made from fibre reinforced plastic. This gives sufficient strength and eliminates the eddy current loss caused by the rotating magnetic field. Should it come into contact with the drive magnet unit, no spark would be generated and a high level of safety would be maintained.

Back pullout system

In order to facilitate inspection and maintenance, this series employs the back pullout system. This enables one to conduct inspections internally and replace parts without removing piping. The pump is designed to include safety measures that can prevent the liquid from leaking when the foot support is pulled back.

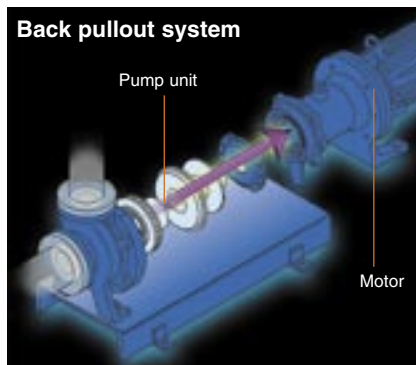

Now available high head models

High head models MDM25-3 and MDM40-2 now join MDM Series which is favoured as fluoroplastic made process magnet drive pump. The models obtain 74 meters head (50Hz), 107 meters head (60Hz) to expand the application.

Compliance with JIS standards

The pump with a common base comply with JIS Standards in regard to piping connection.

Note 1: For compatibility in size with other series of our magnet pumps, please call us.
Note 2: ANSI and ISO standards are also available.

For details, please call us.

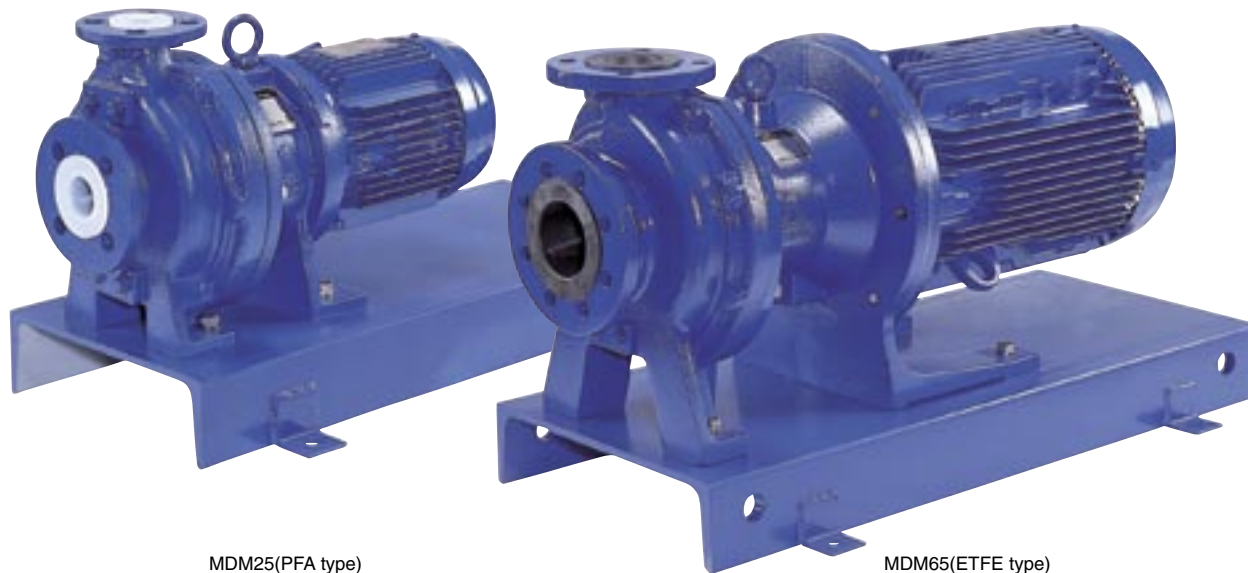

MDM25(PFA type)

MDM65(ETFE type)

Construction

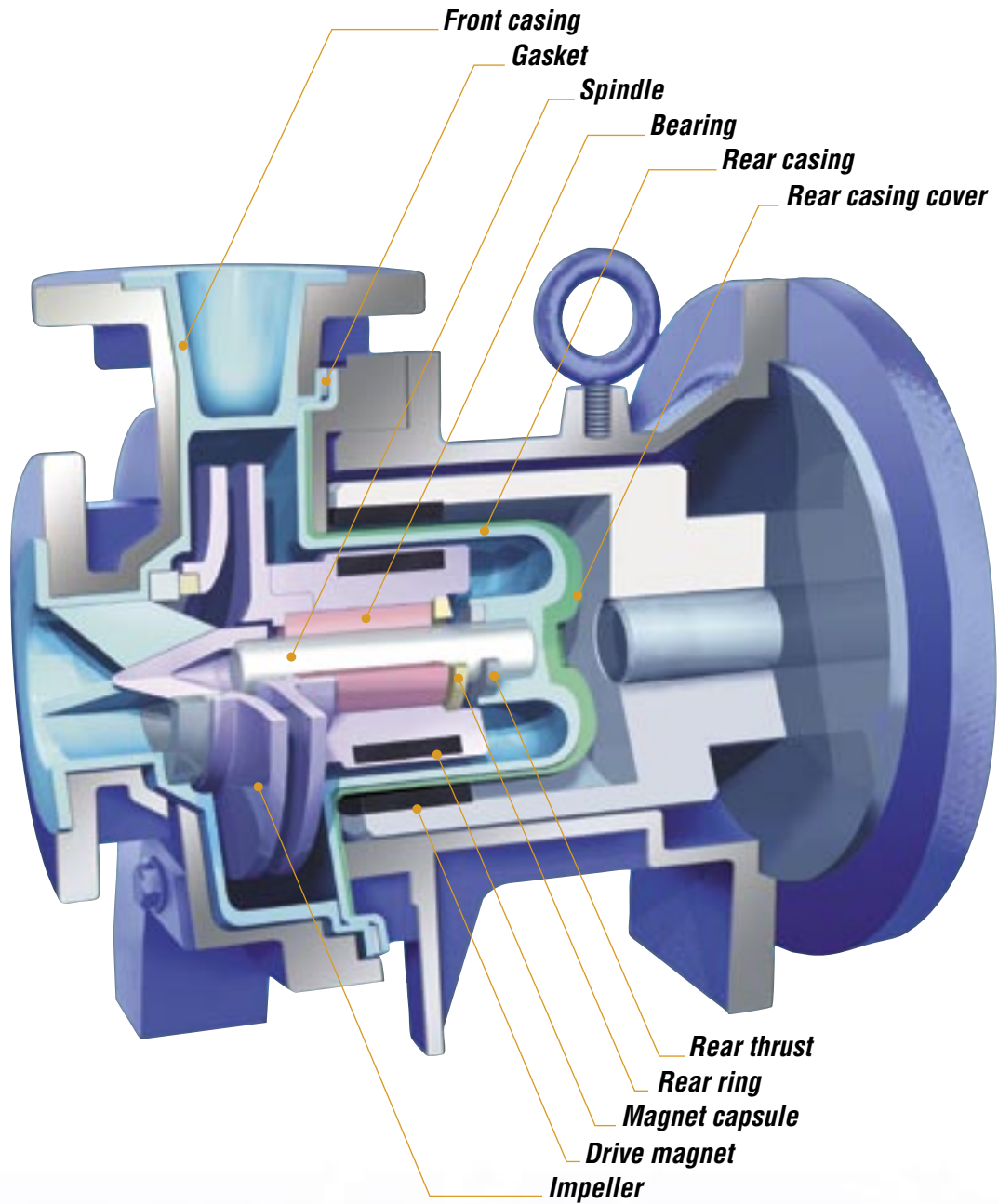

Wet-end materials

	Materials	ECF	EKK	PKK
1	Front casing	CFRETPE	SiC	PFA
2	Rear casing ^(Note 1)			
3	Impeller			
4	Magnet capsule	High purity alumina ceramic	SiC	SiC
5	Bearing			
6	Spindle			
7	Liner ring			
8	Mouth ring	PTFE (with filler)	PTFE	PTFE
9	Rear ring	High purity alumina ceramic		
10	Rear thrust	PTFE (with filler)		
11	Gasket	PTFE		

Note1: Rear casing of MDM25-3 and MDM40-2 for over 80°C application is special construction (Patent pending).

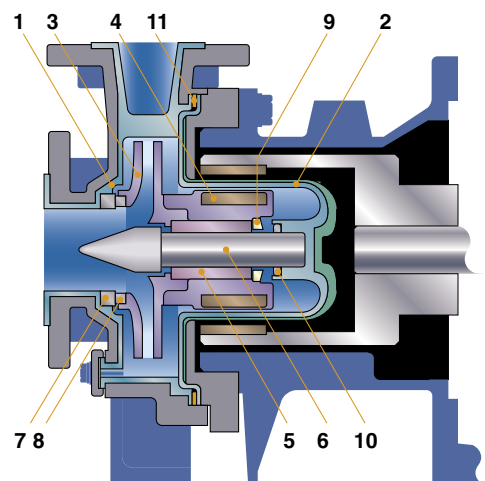

Front casing ETFE type

A moulding made of carbon fibre reinforced ETFE (CFRETFE). It has both a high mechanical strength and excellent corrosion resistance. The outer peripheral surfaces are reinforced by a ductile cast iron outer casing in order to achieve excellent strength and durability.



ETFE type

Front casing PFA type

The ductile cast iron casing is a one-piece moulding with natural PFA fluoro resin lining integrally moulded. This construction is free from contamination and ideal for transfer of clean liquids or with less particle generation.



PFA type

Note: For lower duty MDM25 type a different moulding method is used.

Impeller

Closed type impellers are designed to give high efficiency. To ensure positive fixing of impeller to magnet capsule a spline system together with a pin fixing is employed. This prevents the impeller from moving axially off the magnet capsule (PAT. PEND.). MDM25 and 40 models now have impellers capable of reaching max. heads of 74 meters (50Hz), 107 meters (60Hz) to widen the range of application.



ETFE type



PFA type

Rear casing Rear casing cover

The fluoro resin rear casing is strengthened by the outer rear casing cover which is manufactured in fibre reinforced plastic capable of withstanding a pressure of 1 MPa. This structure also eliminates any eddy current losses due to a rotating magnetic field. It also prevents sparks from being produced should the rear casing come into contact with the drive magnet unit.

A newly developed triple-layer casing (PAT. PEND) is used for the high head models MDM25-3 and 40-2 when liquid temperature exceeds 80°C. This new design allows a rated 1.6MPa casing pressure overall temperature range. Since the front and rear casing are bolted together from the front casing side liquid does not leak out when the foot support is pulled back.



PFA type with rear casing cover

Rear ring

As a precaution against abnormal running, for example cavitation or air entering the pump where the magnet capsule could move axially backwards a rear ring and thrust ring have been incorporated. The rear ring is designed to give minimal heat generation from contact and therefore heat generation is greatly reduced compared to conventional designs. This prevents surrounding fluoro resin from melting. (PAT.PEND.)

Rear Thrust

The rear thrust withstands axial loads encountered from abnormal operation, it also minimizes heat generation.

Magnet capsule

High magnet strength rare earth magnets are totally encapsulated with fluoro resin mouldings. Magnets are small and lightweight which increases the efficiency of the pump. Taking advantage of the high magnetic strength its new design of "Non contact system" was developed to protect pump from dry running. This enables us to offer pumps that will withstand dry running operation. (CF type only)



ETFE type



PFA type

Spindle

Both ends of the spindle are supported by the front casing and the rear casing (the fixed spindle type). There are two types of spindle; one is made of high purity alumina ceramic and the other made of SiC.



SiC type

High purity alumina ceramic type

Bearing

Two standard bearing materials are available. SiC gives high resistance to abrasion. High density carbon withstands dry running operation. Bearings can be individually replaced.



SiC type

High density carbon type

Gasket

A PTFE shrouded gasket is used to enhance sealing performance and corrosion resistance.

Specifications

2 pole motor type

Model	Pump size Suction X Discharge	50Hz			60Hz			Motor kW
		Impeller size	Capacity L/min	Head m	Impeller size	Capacity L/min	Head m	
MDM25-1 (Impeller range 1)	40A X 25A	165	100	35.5	140	100	36.0	1.5 or 2.2
		160		33.5	130		29.5	
		150		29.0	120		24.5	
		140		25.0	110		20.0	
		130		20.5	100		15.5	
MDM25-2 (Impeller range 2)	40A X 25A	195	100	50.5	170	100	53.0	3.7, 5.5 or 7.5
		190		47.5	160		47.0	
		180		42.5	150		40.5	
		170		37.0	140		35.0	
		160		32.5	130		29.0	
MDM25-3 (Impeller range 3)	40A X 25A	225	100	74.0	225	100	107.0	5.5, 7.5, 11, 15 or 18.5 (60Hz only)
		220		69.0	220		102.5	
		210		61.0	210		90.0	
		200		55.0	200		80.0	
		190		48.5	190		71.0	
		180		42.5	180		62.5	
		—		—	170		55.0	
		—		—	160		48.0	
MDM40-1 (Impeller range 1)	50A X 40A	165	208	35.0	145	250	38.0	3.7, 5.5 or 7.5
		160		32.5	140		34.5	
		150		28.5	130		29.0	
		140		25.0	120		24.0	
		130		20.5	110		19.5	
		120		17.0	—		—	
		—		—	—		—	
MDM40-2 (Impeller range 2)	50A X 40A	225	208	70.0	225	250	102.0	5.5, 7.5, 11, 15 or 18.5 (60Hz only)
		220		67.5	220		98.0	
		210		60.0	210		87.0	
		200		54.0	200		78.0	
		190		47.0	190		68.0	
		180		41.5	180		60.5	
		170		38.0	170		53.0	
		160		32.0	160		45.0	
MDM50-1	65A X 50A	165	417	33.0	160	500	44.5	3.7, 5.5 or 7.5
		160		31.0	150		38.0	
		150		27.0	140		33.0	
		140		22.5	130		27.0	
		130		18.0	120		21.5	
		120		15.0	110		18.5	
		110		12.0	—		—	
MDM65-1	80A X 65A	165	833	38.5	160	1000	51.0	5.5, 7.5, 11, 15 or 18.5(60Hz only)
		160		35.5	150		44.5	
		150		31.0	140		37.0	
		140		26.5	130		31.5	
		130		22.0	120		26.0	
		120		17.5	110		20.0	
		110		13.5	—		—	

4 pole motor type

Model	Pump size Suction X Discharge	50Hz			60Hz			Motor kW
		Impeller size	Capacity L/min	Head m	Impeller size	Capacity L/min	Head m	
MDM25-1 (Impeller range 1)	40A X 25A	170	50	8.5	170	50	12.0	0.4, 0.75
MDM25-2 (Impeller range 2)	40A X 25A	200	50	12.0	200	50	18.5	1.5, 2.2, 3.7
MDM25-3 (Impeller range 3)	40A X 25A	225	50	17.0	225	50	24.0	1.5, 2.2, 3.7, 5.5
MDM40-1 (Impeller range 1)	50A X 40A	170	200	7.5	170	200	11.5	1.5, 2.2, 3.7
MDM40-2 (Impeller range 2)	50A X 40A	225	200	15.0	225	200	22.0	1.5, 2.2, 3.7, 5.5
MDM50-1	65A X 50A	170	300	7.0	170	300	11.5	1.5, 2.2, 3.7
MDM65-1	80A X 65A	170	500	8.0	170	500	13.0	1.5, 2.2, 3.7, 5.5

Common Specifications

- Temperature range of liquid handled ETFE type : -20 to 105°C, PFA type : -20 to 150°C Note 1
- Allowable slurry (KK type only) Please contact us.
- Allowable maximum pressure 1.0 MPa (MDM25-3 and MDM40-2 are 1.6 MPa)
- Standard motor 2 pole, 3-phase, TEFC, out door flange mount type
- Standard color of paint Ultra marine blue RAL5002

Note 1: Please contact us when handling liquid temperature is below 0°C or handling liquid temperature is higher than 120°C with PFA type.

Pump identification

MDM 40 - 150 1 E KK F 075 J - D 2 H																						
1		2		3		4		5		6		7		8		9		10		11		
1	Pump size (Suction X Discharge)	25: 40A X 25A	5	Material of Bearing / Spindle	KK: SiC/SiC CF: High density carbon/ High purity alumina ceramic	9	Special version	Mark	Drain	Base	Special version	A	Without drain	With base	Standard	S	Special	D	With drain	Standard	X	Special
		40: 50A X 40A																				
2	Impeller size	100mm to 225mm	7	Motor output	004: 0.4kW(4P) 075: 7.5kW(2P) 007: 0.75kW(4P) 110: 11kW(2P) 015: 1.5kW 150: 15kW(2P) 022: 2.2kW 185: 18.5kW(2P) 037: 3.7kW (60Hz only) 055: 5.5kW	10	Motor pole	2: 2 pole 4: 4 pole	E	Without drain	Without base	Special	Y	Standard	Z	With drain	Standard	E	Special	T: 120 to 150°C		
		50: 65A X 50A																				
3	Impeller range	1, 2, 3																				
4	Wet-end main material	E: CFRETFE P: PFA	8	Standard for pipe connection and motor	J: JIS flange + JIS motor A: ANSI flange + JIS motor I: ISO flange + IEC motor																	

Performance curves

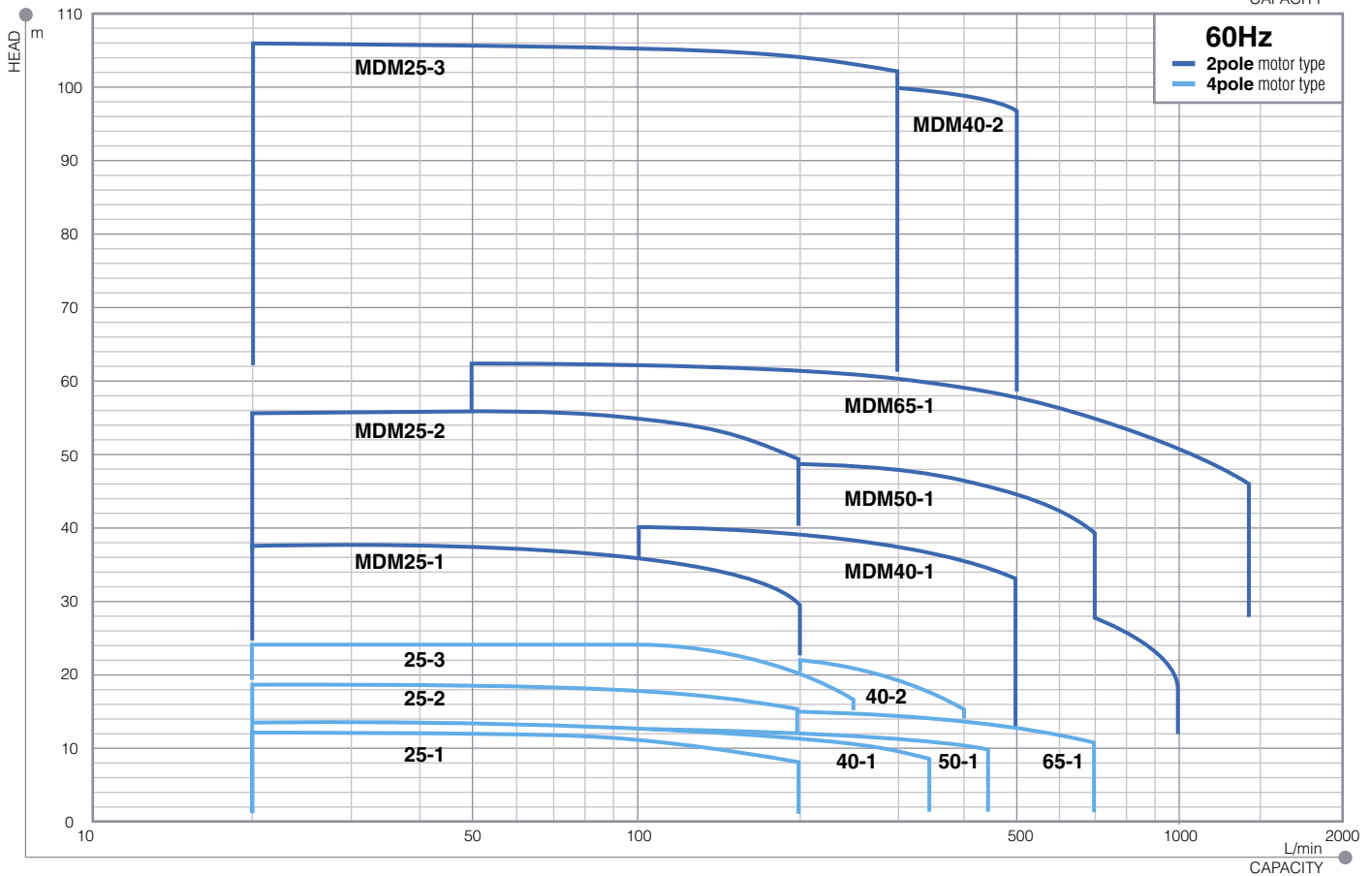
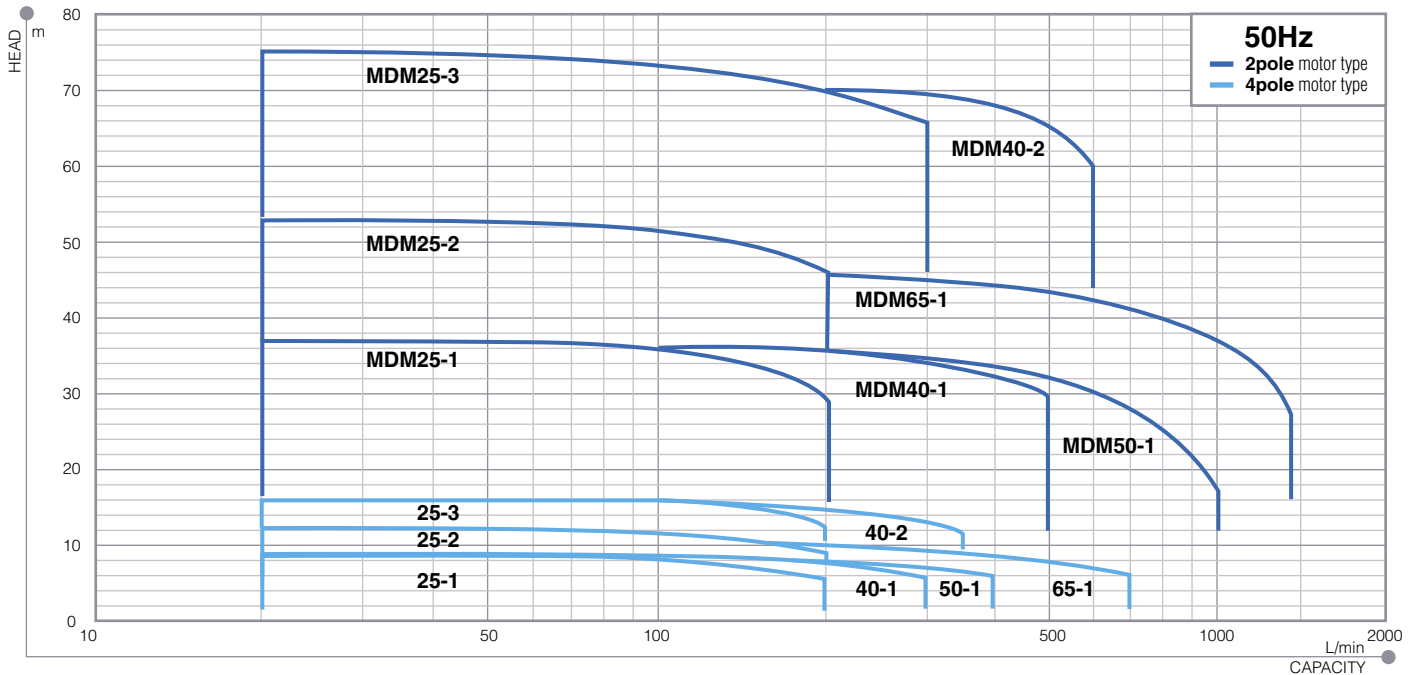

Iwaki dry running protector DR series (Option)

Model DR is electric current sensing type dry running protector. It detects the decreased load current (lower limit) to stop the pump when it runs dry or runs with air sucking in. It can detect over-load, too.



Specification

	DR-20	DR-21	50/60Hz
Model			
Motor power		380 to 440V	
Applied motor	0.75 to 15kW	18.5 to 75kW	
Power	200 to 240V 10% shingle phase		
45-65Hz Input		3.5W	
Detective current	0.5 to 32.0A	20 to 200A	
Current transformer(CT)	Built-in	External	
Current range	Auto 4.4/17.6/32A Manual 2/2.4/8/8/11/17.6/26.4/32A	0 to 200A	
Ambient	Temperature: 0 to 40°C Humidity: RH40 to 85%		
Outer dimension	D80 X W153 X H110		

Dimensions

2 pole motor type

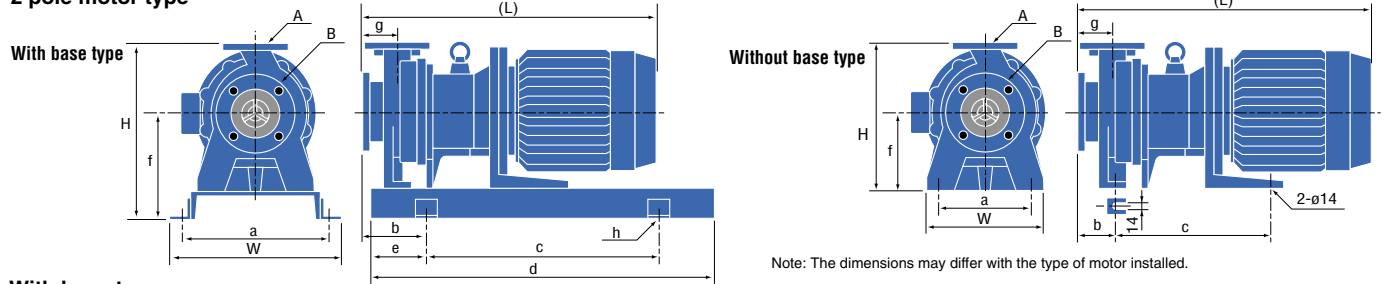

Note: The dimensions may differ with the type of motor installed.

With base type

Model	Motor	W	H	(L)	a	b	c	(d)	(e)	f	g	h	A	B	Mass kg
MDM25-1	1.5kW	400	400	515	350	135	480	710	115	240	80	4-ø19	25	40	80
	2.2kW			625											120
MDM25-2	3.7kW	400	430	625	350	150	540	800	130	250	80	4-ø19	25	40	140
	5.5kW			689											140
	7.5kW			689											140
MDM25-3	5.5kW	400	415	711	350	172	540	800	130	250	102	4-ø19	25	40	145
	7.5kW			150											
	11kW	480	485	864	430	192	600	900	150	320	102	4-ø19	25	40	215
	15kW			225											
	18.5kW			235											
MDM40-1	3.7kW	400	410	625	350	150	540	800	130	250	80	4-ø19	40	50	115
	5.5kW			689											135
	7.5kW			689											135
MDM40-2	5.5kW	400	430	689	350	150	540	800	130	250	80	4-ø19	40	50	150
	7.5kW			155											
	11kW	480	500	842	430	170	600	900	150	320	80	4-ø19	40	50	220
	15kW			230											
MDM50-1	3.7kW	400	410	625	350	150	540	800	130	250	80	4-ø19	50	65	115
	5.5kW			689											135
	7.5kW			689											135
MDM65-1	5.5kW	400	430	709	350	170	540	800	130	250	100	4-ø19	65	80	145
	7.5kW			210											
	11kW	480	500	862	430	190	600	900	150	320	100	4-ø19	65	80	220
	15kW			220											
18.5kW	884	230													

Without base type

Model	Motor	W	H	(L)	a	b	c	f	g	A	B	Mass kg
MDM25-1	1.5kW	180	310	515	130	100	150	150	80	25	40	55
	2.2kW			625								95
MDM25-2	3.7kW	280	360	625	220	90	285	180	80	25	40	95
	5.5kW			689								110
	7.5kW			689								110
MDM25-3	5.5kW	280	345	711	220	112	365	180	102	25	40	115
	7.5kW			120								
	11kW	395	864	220	112	450	230	102	25	40	165	
	15kW										175	
	18.5kW										185	
MDM40-1	3.7kW	280	340	625	220	90	285	180	80	40	50	90
	5.5kW			689								105
	7.5kW			689								105
MDM40-2	5.5kW	280	360	689	220	90	365	180	80	40	50	120
	7.5kW			125								
	11kW	410	842	220	90	450	230	80	40	50	170	
	15kW										180	
18.5kW	864	190										
MDM50-1	3.7kW	280	340	625	220	90	285	180	80	50	65	85
	5.5kW			689								105
	7.5kW			689								105
MDM65-1	5.5kW	280	360	709	220	110	365	180	100	65	80	120
	7.5kW			165								
	11kW	410	862	220	110	450	230	100	65	80	175	
	15kW										185	
18.5kW	884	185										

www.iwakipumps.jp

IWAKI CO.,LTD. 6-6 Kanda-Sudacho 2-chome Chiyoda-ku Tokyo 101-8558 Japan TEL : (81)3 3254 2935 FAX : 3 3252 8892

EUROPE / U.S.A.

European office :	IWAKI Europe GmbH	TEL: (49)2154 9254 0	FAX: 2154 9254 48
Austria :	IWAKI (Austria) GmbH	TEL: (41)26 674 93 00	FAX: 26 674 93 02
Belgium :	IWAKI Belgium N.V.	TEL: (32)13 67 02 00	FAX: 13 67 20 30
Denmark :	IWAKI Nordic A/S	TEL: (45)48 24 2345	FAX: 48 24 2346
Finland :	IWAKI Suomi Oy	TEL: (358)9 2745810	FAX: 9 2742715
France :	IWAKI France S.A.	TEL: (33)1 69 63 33 70	FAX: 1 64 49 92 73
Germany :	IWAKI Europe GmbH	TEL: (49)2154 9254 50	FAX: 2154 9254 55
Holland :	IWAKI Holland B.V.	TEL: (31)297 241121	FAX: 297 273902
Italy :	IWAKI Italia S.R.L.	TEL: (39)02 990 3931	FAX: 02 990 42888
Norway :	IWAKI Norge AS	TEL: (47)66 81 16 60	FAX: 66 81 16 61
Spain :	IWAKI Iberica Pumps, S.A.	TEL: (34)943 630030	FAX: 943 628799
Sweden :	IWAKI Sverige AB	TEL: (46)8 511 72900	FAX: 8 511 72922
Switzerland :	IWAKI (Schweiz) AG	TEL: (41)26 674 93 00	FAX: 26 674 93 02
U.K. :	IWAKI Pumps (UK) Ltd.	TEL: (44)1743 231363	FAX: 1743 366507
U.S.A. :	IWAKI America Inc.	TEL: (1)508 429 1440	FAX: 508 429 1386

ASIA / OCEANIA

Australia :	IWAKI Pumps Australia Pty Ltd.	TEL: (61)2 9899 2411	FAX : 2 9899 2421
China :			
Hong Kong :	IWAKI Pumps Co., Ltd.	TEL: (852)2607 1168	FAX: 2607 1000
Shanghai :	IWAKI Pumps (Shanghai) Co., Ltd.	TEL: (86)21 6272 7502	FAX: 21 6272 6929
Guangzhou :	GFTZ IWAKI Engineering & Trading Co., Ltd.	TEL: (86)20 8435 0603	FAX: 20 8435 9181
Beijing :	GFTZ Iwaki Engineering & Trading Co., Ltd. (Beijing office)	TEL: (86)10 6442 7713	FAX: 10 6442 7712
Korea :	IWAKI Korea Co.,Ltd.	TEL: (82)2 2630 4800	FAX: 2 2630 4801
Malaysia :	IWAKIm Sdn. Bhd.	TEL: (60)3 7803 8807	FAX: 3 7803 4800
Singapore :	IWAKI Singapore Pte Ltd.	TEL: (65)6316 2028	FAX: 6316 3221
Indonesia :	IWAKI Singapore (Indonesia Branch)	TEL: (62)21 6906606	FAX: 21 6906612
Taiwan :	IWAKI Pumps Taiwan Co., Ltd.	TEL: (886)2 8227 6900	FAX: 2 8227 6818
Thailand :	IWAKI (Thailand) Co.,Ltd.	TEL: (66)2 322 2471	FAX: 2 322 2477
Vietnam :	IWAKI Pumps Vietnam Joint Venture Co., Ltd.	TEL: (84)613 933456	FAX: 613 933399

() Country codes



Caution for safety use: Before use of pump, read instruction manual carefully to use the product correctly.

Actual pumps may differ from the photos. Specifications and dimensions are subject to change without prior notice. For further details please contact us.